

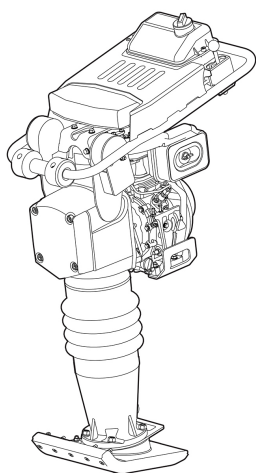

Dynapac DR8D

Rammers





Technical data

 Masses	
Net mass	84 kg
Operating mass	86 kg

 Traction	
Max. working speed	20 m/min

 Compaction	
Impact force, kN	17.5
Vibration frequency	10.0 – 12.0 Hz

 Engine	
Manufacturer/Model	Yanmar L48N
Number of cylinders	1
Type	Air Cooled Diesel
Emissions according to	Non -Regulated
Rated power	3.50 kW
Fuel tank capacity	3 l

 Drive system	
Drive system	Mechanical

Find us locally at www.dynapac.com

We reserve the right to change specifications without notice. Photos and illustrations do not always show standard versions of machines. The above information is a general description only, all informations are supplied without liability.

Dynapac DR8D

Rammers



Technical data

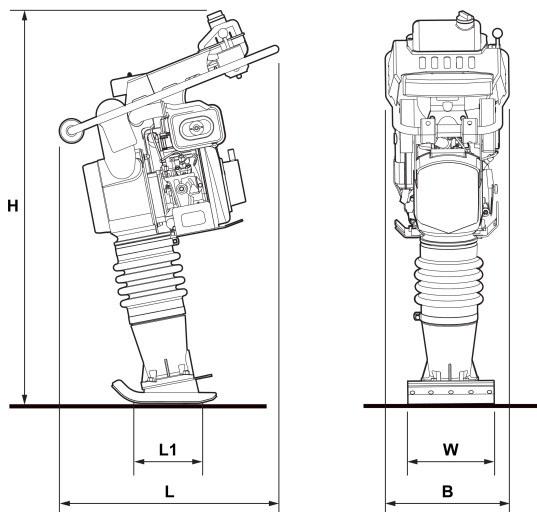

Dimensions	
B. Width	400 mm
H. Height	1150 mm
L. Length	760 mm
L1. Length	210 mm
W. Basic shoe width	280 mm



Standard equipment

- Low vibration handle
- Fuel filtration system
- Dual stage air filtration system
- Recoil starter
- Loading aid rollers on Handle
- One point lift

Find us locally at www.dynapac.com

We reserve the right to change specifications without notice. Photos and illustrations do not always show standard versions of machines. The above information is a general description only, all informations are supplied without liability.